

Increasing wear resistance of components made of 50MnSi4 steel by Fe-Cr-C-Mo based hardfacing alloys

Pavol Sejč^{1*}, Tomáš Világoš², Zuzana Gábrišová¹, Branislav Vanko¹

¹*Faculty of Mechanical Engineering, Slovak University of Technology, 812 31 Bratislava, Slovak Republic*

²*Bratislava Public Transit Company, Slovak Republic*

Received 11 July 2022, received in revised form 27 October 2022, accepted 2 November 2022

Abstract

The work aims to evaluate the possibility of increasing the resistance of 50MnSi4 steel to wear by hardfacing Fe-Cr-C-Mo type alloys. For this purpose, two types of filler metals for gas metal arc welding (GMAW) were used – Carbofil A 350 and Magmaweld FCH 360. Metallographic evaluation of the hardfacing structure was performed on the prepared samples, supplemented by hardness measurement. Standard tribological tests were used to test adhesive and abrasive wear resistance. The test results clearly showed that the types of filler metals used for weld cladding significantly increased the resistance of the 50MnSi4 steel substrate to adhesive and abrasive wear. When evaluating the adhesive wear, the positive effect of the hardfacing was manifested not only by a decrease in the weight loss of the samples but also by the coefficient of friction. In the case of the evaluation of resistance to abrasive wear, the best indicators were found in the application of the filler metal Magmaweld FCH 360, where the highest hardness of the martensitic structure of the hardfacing 719 HV_{0.2} was noticed.

Key words: hardfacing, weld cladding, gas metal arc welding, adhesive wear, abrasive wear

1. Introduction

Wear is currently a significant problem in evaluating the service life of machinery or its components. In practice, we also encounter different types of interactions between machine parts or between machine parts and the environment, which predict the manner and extent of their surface damage. The direct consequence is a change in the shape and dimensions of the worn components until the machine parts cease to fulfil their function. Wear thus becomes a part of our lives, it is not possible to eliminate it, but it is possible, based on a thorough knowledge of the mechanisms of wear, to extend the life of machine parts by appropriate selection of materials for their production or by creating a protective layer that will better withstand wear conditions [1–3].

One way to extend the life of a machine part is to create a layer by hardfacing. Almost all fusion welding methods can be used for depositing wear-resistant layers [4–9]. The choice of technology depends not only on the size and shape of the part (fusion face) but

also on the thickness of the coating.

A wide range of filler metals is available for wear-resistant layers. They are produced in the form of wires or powders and are suitable for hardfacing not only by arc welding methods (GMAW, GTAW) but also by laser or electron beam [10–15].

It is recommended to use high-hardness coatings both in the case of adhesive wear without lubricant and in the case of abrasive wear [4, 16]. Fe-based hardfacing alloys are often used to overlay parts made of non-alloy steel. Their high hardness is ensured by the alloying of Cr, Nb, Ti, and Mo, which form hard carbides or borides in the structure [11, 12, 17–22].

High-chromium steels are widely used for hardfacing industrial components in cement plants, the steel industry and thermal power plants. The high hardness and increased wear resistance of the coatings are mainly attributed to the formation of chromium carbides. However, the wear resistance of the Fe-Cr-C-Mo alloy depends not only on the type but also on the shape and distribution of the hard phases, as well as on the resistance of the matrix [23–27].

*Corresponding author: e-mail address: pavol.sejc@stuba.sk

Despite a significant increase in hardness, adding chromium carbides in ferrite promotes wear resistance only very slightly. The wear-resistant properties of carbides do not appear in this case because they are suppressed by the presence of soft ferrite. Therefore, a high degree of alloying does not guarantee good wear resistance.

Even a martensitic-carbide structure with high hardness does not ensure maximum wear resistance because it does not sufficiently resist surface breakdown in the phase when the resistance is determined by interatomic bonds and the bond strength between the structural components at grain boundaries. Many cracks of an endogenous nature can damage martensite. Cracks can also be expected at the boundaries between martensite and carbides (due to the different types and dimensions of the crystal lattices). The incoherence will thus facilitate the peeling of carbides from the martensitic matrix after collision with the abrasive.

The structure of the overlay will be influenced not only by the initial chemical composition of the filler and base metal but also by the used technology and weld cladding parameters or heat treatment of the coating. Hardfacing steels with higher carbon content and alloying elements require preheating to prevent cracks [28, 29]. In addition, the cladding technology and process parameters will affect the degree of overlay/substrate intermixing. A higher degree of intermixing will degrade the properties of the deposit. It is, therefore, generally recommended to use conditions for the production of hardfacing layers where the degree of mixing is less than 20 % [30].

The appropriate chemical composition of the filler metal, preheating, and heat input, which determine the course of the weld cladding temperature cycle, and any heat treatment of the deposit will thus be decisive for achieving the required hardfacing properties.

The work aims to evaluate the possibilities of using selected types of hardfacing materials to increase the wear resistance of 50MnSi4 steel.

2. Experimental procedure

Steel grade 50MnSi4 (EN 10027-1) was used as the substrate intended for hardfacing. According to EN 10027-2, we can classify the material in class 1.5131. The chemical composition of steel is given in Table 1. Based on the chemical composition determined by the standard (Table 1), the material used belongs to the group of low-alloy manganese steels. The material is intended for heat treatment and is used for heavily stressed machine parts. Draw hooks for coupling railway vehicles, for example, are made of this material by hot forging.

Two types of filler metal were used for weld

Table 1. Chemical composition of 50MnSi4 steel according to standard EN 10027-2 (wt.%)

| C | Si | Mn | P | S |
|-----------|-----------|-----------|------------|------------|
| 0.45–0.53 | 0.70–1.00 | 0.90–1.20 | 0.00–0.035 | 0.00–0.035 |

Table 2. Content of elements in the Carbofil A 350 filler metal (wt.%) [31]

| C | Si | Mn | Mo | Cr |
|------|------|------|------|------|
| 0.70 | 0.50 | 2.00 | 1.00 | 1.00 |

Table 3. Additional data about Carbofil A 350 filler metal [31]

| Standard EN 14700 | Hardness (HB/HV*) | Diameter (mm) |
|-------------------|-------------------|---------------|
| S Fe 2 | 325–380/345–400 | ø 1.2 |

*Values determined using EN ISO 18265 (Table A.1 – Conversion of hardness-to-hardness or hardness-to-tensile-strength values for unalloyed and low alloy steels and cast steel)

cladding, suitable for GMAW technology: Carbofil A 350 and Magmaweld FCH 360, both with a diameter of 1.2 mm.

According to the manufacturer's specification, the Carbofil A 350 filler metal is a medium-alloy wire for hardfacing parts exposed to strong impact wear [31]. Coatings without heat treatment reach a hardness of 325 to 380 HB. Nevertheless, the weld metal can still be machined. The filler metal is used by the GMAW with M21 shielding gas (according to EN ISO 14175). The content of elements in all-weld metal is given in Table 2. Additional data about filler metal are given in Table 3. The hardness values given by the manufacturer are in HB units. As the hardness measurement on the experimental materials was performed in HV units, the conversion of hardness units according to EN ISO 18265 was performed for comparison. However, these values are only indicative.

The Magmaweld FCH 360 filler metal is a flux-cored wire designed for hardfacing deposits with high hardness. According to the manufacturer, the hardness of the overlay reaches a value of up to 59 HRC, which maintains even at high temperatures around 600 °C [32]. Any heat treatment after coating reduces its hardness. It is recommended for weld cladding by the GMAW, and either pure CO₂ (C1 according to EN ISO 14175) or a gas mixture M21 can be used as shielding gas. Weld metal is resistant to cracking and shall not be welded more than 3 passes. The content

Table 4. Content of elements in the Magmaweld FCH 360 filler metal (wt.%) [32]

| C | Si | Mn | Cr | Mo | Fe |
|------|------|------|------|------|------|
| 0.60 | 0.70 | 1.60 | 5.00 | 0.40 | rest |

Table 5. Additional data about Magmaweld FCH 360 filler metal [32]

| Standard EN 14700 | Hardness (HRC/HV*) | Diameter (mm) |
|----------------------|-----------------------|------------------|
| T Fe 6 | 59/675 | ∅ 1.2 |

* Values determined using EN ISO 18265 (Table A.1 – Conversion of hardness-to-hardness or hardness-to-tensile-strength values for unalloyed and low alloy steels and cast steel)

of elements in all-weld metal is given in Table 4. Additional data about filler metal are given in Table 5. The deposit hardness value given by the manufacturer in HRC units was supplemented by HV values according to EN ISO 18265. These values are, again, only indicative.

The following was realized on the prepared hardfacing surfaces:

1. Checking the integrity in the raw state by visually inspecting the surface (visual testing).
2. Evaluation of the structure of coatings carried out on cross-sections. (Standard metallographic procedures were used to prepare the samples.)
3. Measurement of the hardness (from the deposit over the heat-affected zone to the substrate) by the Vickers method.
4. Testing the resistance of hardfacing surfaces to adhesive wear using the “Pin on Disc” test. Data obtained from the “Pin on Disc” test:
 - A. coefficient of friction.
 - B. resistance of weld claddings (and reference sample) to adhesive wear.
5. Testing weld claddings (and reference sample) against abrasive wear.

The obtained results were used to compare the wear resistance of overlays made of the mentioned filler metals and to evaluate the resistance to adhesive and abrasive wear of coatings to the substrate material 50MnSi4.

3. Results and discussion

3.1. Evaluation of the structure and hardness of deposits

Samples measuring $120 \times 90 \times 50 \text{ mm}^3$ for hard-

facing were produced by mechanical cutting. Before weld cladding, the samples were ground with an angle grinder. Due to the chemical composition of the base material, which is given in Table 1, the used steel 50MnSi4 is evaluated as difficult to weld (0.45 to 0.53 % C). The difficulty lies in the restrictive welding conditions: preheating, interpass temperature and post-weld heat treatment. In this case, preheating was used before weld cladding. The procedure in EN 1011-2: 2003 could not be applied to determine the preheating temperature (T_p) because the carbon content of the steel exceeded the maximum value of 0.32 wt.% specified in the standard. For this reason, the Seférian relation [33] was used to calculate the preheating temperature of the steel:

$$T = 350\sqrt{C_p - 0.25} \text{ (}^\circ\text{C)}, \quad (1)$$

where

$$C_p = C_c + C_d, \quad (1.1)$$

$$C_c = \frac{360C + 40(Mn + Cr) + 20Ni + 28Mo}{360}, \quad (1.2)$$

$$C_d = 0.005hC_c, \quad (1.3)$$

where h is a material thickness (mm); in our case, it is 60 mm.

Based on the above procedure and the chemical composition of the base material (Table 1), the minimum preheating temperature (T_p) of 270 °C was determined. The oxygen-acetylene flame was used for heating, and temperature control was performed with a non-contact thermometer.

The selection of weld cladding parameters was based on the requirements for minimal overlay/surface intermixing and reduction of the width of the heat-affected zone (HAZ). The specific hardfacing parameters used to ensure the minimum heat input to the base metal are in accordance with the manufacturer’s recommendations for the used filler metal with a diameter of 1.2 mm.

The specific heat input for coating the individual samples was calculated according to the standard EN 1011-1: 2008 from the relation:

$$Q = \frac{UI}{10^3v}\eta \text{ (kJ mm}^{-1}\text{)}, \quad (2)$$

where U is the welding voltage (V), I is the welding current (A), v is the welding speed (mm s^{-1}), and η is the welding process efficiency factor (0.8).

The weld cladding parameters for the Carbofil A 350 filler metal are given in Table 6. Substrate material made of 50MnSi4 steel was coated only with a single pass, and five welding beads were placed side

Table 6. Hardfacing parameters for Carbofil A 350

| Weld bead number | Current I (A) | Voltage U (V) | Welding time t (s) | Length of the weld bead L (mm) | Welding speed v (mm s ⁻¹) | Heat input Q (kJ mm ⁻¹) | Current type/ Polarity |
|------------------|-----------------|-----------------|----------------------|----------------------------------|---|---------------------------------------|---------------------------|
| 1 | 240 | 17 | 9 | 45 | 5 | 0.653 | DC/+ |
| 2 | 196 | 17 | 8 | 47 | 5.9 | 0.498 | DC/+ |
| 3 | 196 | 18.5 | 9 | 48 | 5.4 | 0.527 | DC/+ |
| 4 | 195 | 18.4 | 8 | 49 | 6.1 | 0.457 | DC/+ |
| 5 | 191 | 18.3 | 7 | 46 | 6.6 | 0.428 | DC/+ |

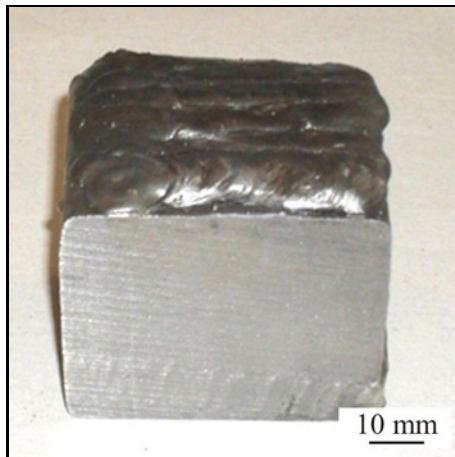

Fig. 1. Overlaid sample.

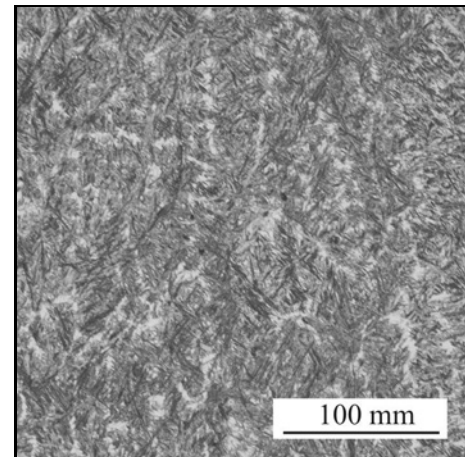

Fig. 3. Microstructure of a deposited layer made of Carbofil A 350.

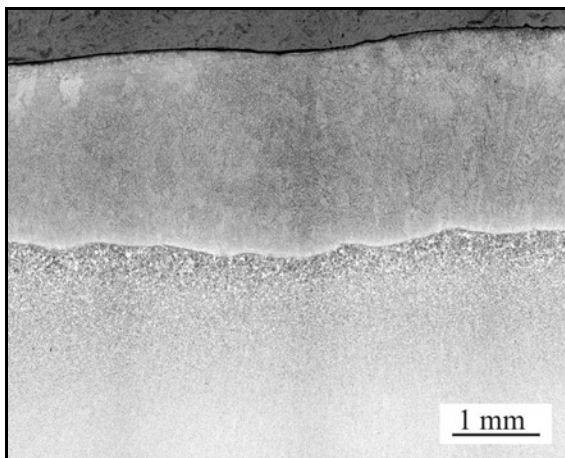

Fig. 2. Structure of a hardfacing made of Carbofil A 350.

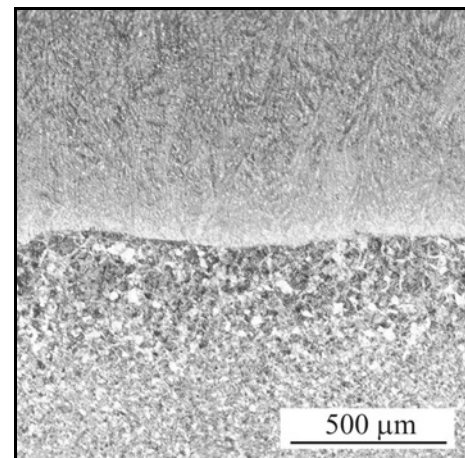

Fig. 4. Microstructure of substrate HAZ under the deposited layer made of Carbofil A 350.

by side (Fig. 1). No surface defects were identified on the coated samples by visual inspection.

Figure 2 shows the coating structure made of Carbofil A 350 filler metal. The structure shows no defects; the remelting depth is uniform. The microstructure of the hardfacing sample is typically martensitic (Fig. 3). In HAZ, the grain of the substrate is coarsened but without decarburization (Fig. 4).

Figure 5 shows the microstructure of heat-unaffected base metal. It is clear from the metallographic cross-sectional cut that the structure of the steel 50MnSi4 used is formed by a polyhedral ferritic-pearlitic structure, while the ferrite forms a mesh along the boundaries of the pearlite grains. The base material had an average hardness of 226 HV₁₀.

Figure 6 shows the overall hardness profile of the

Table 7. Surfacing parameters for Magmaweld FCH 360

| Weld bead number | Current I (A) | Voltage U (V) | Welding time t (s) | Length of the weld bead L (mm) | Welding speed v (mm s ⁻¹) | Heat input Q (kJ mm ⁻¹) | Current type/ Polarity |
|------------------|-----------------|-----------------|----------------------|----------------------------------|---|---------------------------------------|---------------------------|
| 1 | 175 | 17 | 9 | 45.5 | 5.1 | 0.471 | DC/+ |
| 2 | 173 | 17 | 8 | 42 | 5.3 | 0.448 | DC/+ |
| 3 | 169 | 17.2 | 8 | 43.5 | 5.4 | 0.428 | DC/+ |
| 4 | 170 | 17 | 8 | 44 | 5.5 | 0.420 | DC/+ |
| 5 | 167 | 17 | 8 | 43.5 | 5.4 | 0.418 | DC/+ |

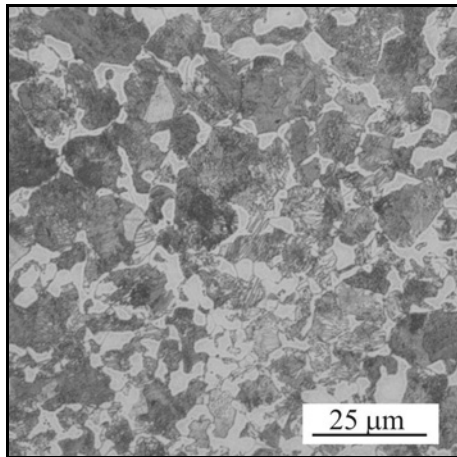

Fig. 5. Microstructure of base material 50MnSi4.

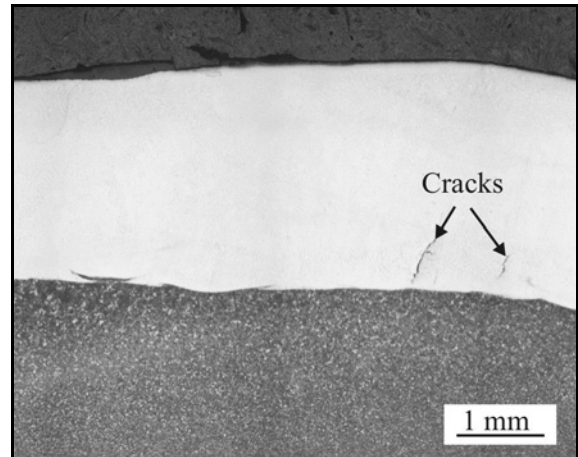

Fig. 7. Structure of a hardfacing made of Magmaweld FCH 360.

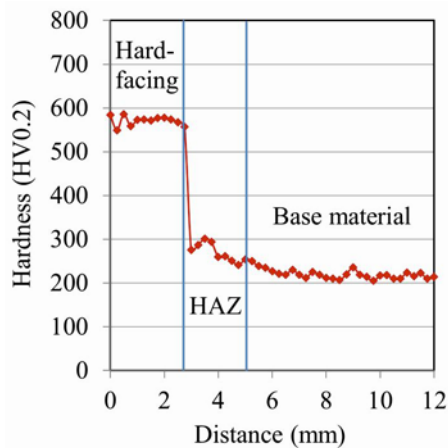

Fig. 6. Hardness profile of the sample with a deposited layer made of Carbofil A 350 filler metal.

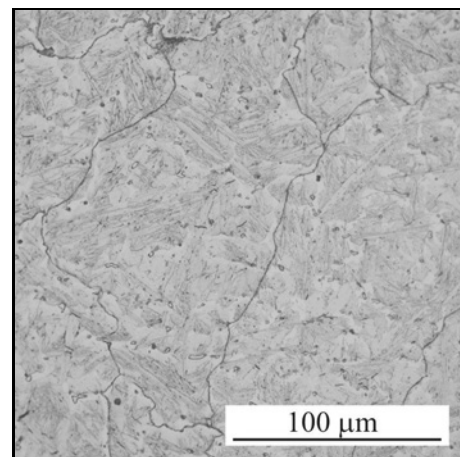

Fig. 8. Microstructure of a deposited layer made of Magmaweld FCH 360.

overlay made of Carbofil A 350 filler metal. The determined thickness of the deposited layer was 2.75 mm. The highest hardness of 586 HV_{0.2} was measured just below its surface. The hardness of the coating was uniform, and the difference between the minimum and maximum values was only 35 HV_{0.2}. The hardness of the obtained hardfacing is higher than the value declared by the manufacturer (Table 3). The substrate HAZ width was 2.25 mm. The measured hard-

ness ranged from 301 to 241 HV_{0.2}. The sharp interface between the hardfacing and the substrate HAZ is identified by a significant hardness decrease.

The weld cladding parameters for the Magmaweld FCH 360 filler metal are given in Table 7. Substrate material made of 50MnSi4 steel was coated only with a single pass, and five welding beads were placed side by side (Fig. 1).

Figure 7 shows the structure of a Magmaweld

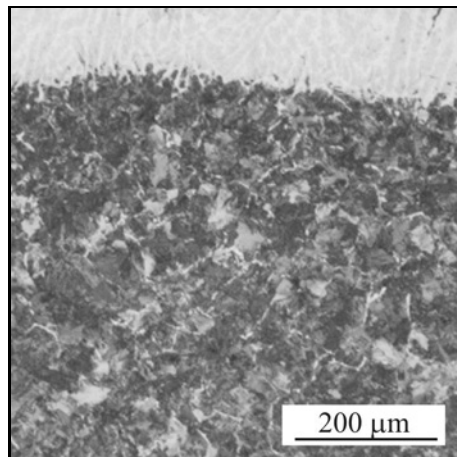

Fig. 9. Microstructure of substrate HAZ under the deposited layer made of Magmaweld FCH 360.

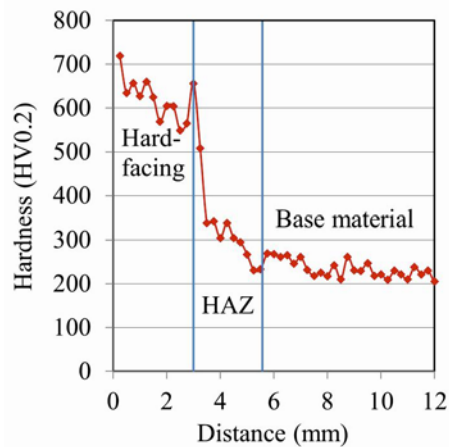

Fig. 10. Hardness profile of the sample with a deposited layer made of Magmaweld FCH 360 filler metal.

FCH 360 filler metal coating. The structure shows the local presence of microcracks with a length of 0.8 and 0.2 mm near the overlay/substrate interface. The microstructure of the deposited layer is martensitic (Fig. 8). The HAZ of the substrate has a coarse pearlitic microstructure with partial ferritic mesh in the transition between the base metal and the overlay (Fig. 9).

The hardness profile of the overlay made of Magmaweld FCH 360 filler metal is shown in Fig. 10. The highest hardness value of 719 HV_{0.2} was again measured just below the coating surface. However, the difference in the measured values of the hardness of the hardfacing, in this case, was significantly larger than in the Carbofil A 350 filler metal and ranged between the maximum value of 719 HV_{0.2} and the minimum value of 508 HV_{0.2}. The average value of the hardness of the deposit corresponded to the hardness declared by the filler metal manufacturer (Table 5). The over-

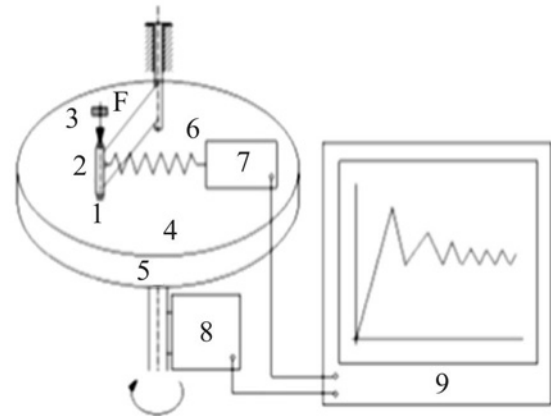

Fig. 11. Pin on Disc wear test (1 – pin; 2 – mounting and guide for pin; 3 – load force; 4 – disc surface; 5 – disc; 6 – load cell; 7 – load cell sensor; 8 – speed sensor; 9 – registration device).

lay width was 3 mm, and HAZ in the substrate was 2.75 mm. The HAZ hardness ranged from 343 HV_{0.2} (in the CGHAZ) to 233 HV_{0.2} (in the unaffected base material).

3.2. Adhesive wear characteristics of hardfacing alloys

In the “Pin on Disc” adhesive wear test (Fig. 11), the discs (no. 5) were made of a substrate metal of 50MnSi4 steel, with an outer diameter of 138 mm, and the inner hole with a diameter of 80 mm. The thickness of the discs used was from 5 to 7 mm. The test surfaces of the wheels were machined by grinding. To determine the wear resistance of the hardfacings, specimens – pins (no. 1) with a diameter of 8 mm and a length of 12 to 16 mm were produced from the overlaid samples by electro-spark separation. Before the test, the surfaces were ground in a plane (Fig. 12), creating contact areas of 50.27 mm². For comparison, non-hardfaced pins (from now on referred to as reference specimens) with the same dimensions were also tested. The aim was to compare the behavior of the substrate steel grade 50MnSi4 under adhesive wear with the behavior of coatings obtained from filler metals Carbofil A 350 and Magmaweld FCH 360.

After the “Pin on Disc” adhesive wear test, a coefficient of friction was calculated according to the relation:

$$\mu = \frac{F_T}{F_N} (-), \quad (3)$$

where F_T is a friction force (N) and F_N is a normal force (N).

A loading (normal) force $F_N = 5.027$ N was used in the test, which created a pressure of 0.1 MPa between

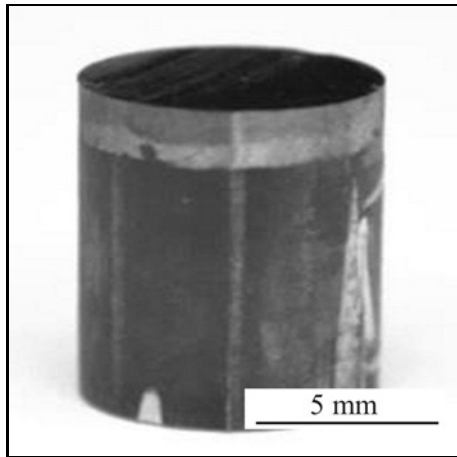

Fig. 12. Pin (specimen) with coating on top.

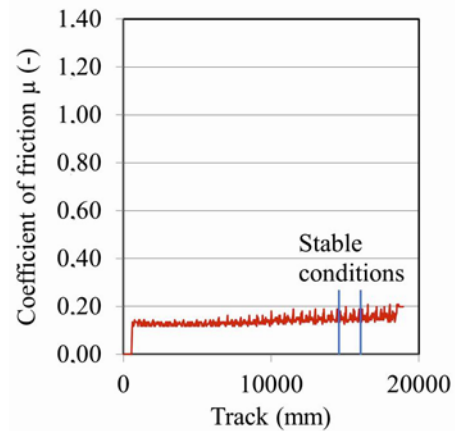

Fig. 15. Dependence of the coefficient of friction on the track of a specimen with the Magmaweld FCH 360 hardfacing.

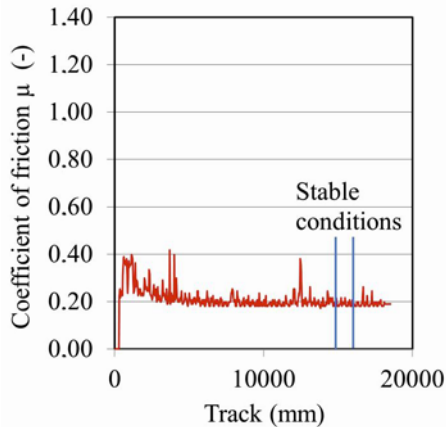

Fig. 13. Dependence of the coefficient of friction on the track of a reference specimen made of 50MnSi4 substrate steel.

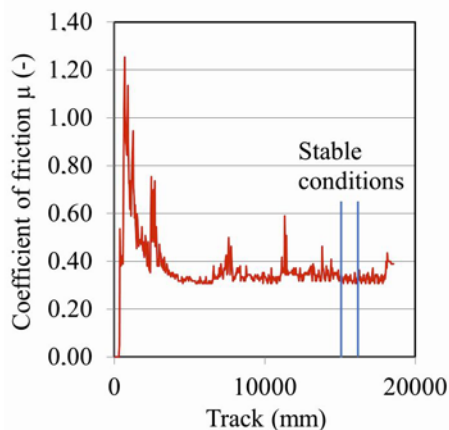

Fig. 14. Dependence of the coefficient of friction on the track of a specimen with the Carbofil A 350 hardfacing.

the contact surfaces. The disc rotated at 20 rpm for three minutes. The diameter of the circular path described by the pin during one revolution was 110 mm, thus realizing a track of 20 m during the test.

The progress of the friction force was measured by a calibrated load cell. The results (profiles) of the coefficient of friction using the reference specimen and the surfaced specimen are shown in Figs. 13–15.

As can be seen from Figs. 13 and 14, after the initial (running-in) phase, which is characterized by significant changes in the coefficient of friction, the friction conditions between the worn surfaces gradually stabilized. Therefore, for further evaluation of the properties of the used specimens (reference and hardfaced), the data obtained during the stable conditions of the wear test after passing the track with a length of 15 m were further used. The obtained values of the coefficient of friction are given in Table 8.

The resistance to adhesive wear was evaluated by the weight loss of the specimen W_m (g), and the intensity of the volume wear $W_{V/s}$ ($\text{mm}^3 \text{m}^{-1}$). The specimens were subjected to a contact pressure of 3.0 MPa during the test. The size of the wear was determined by weighing it on laboratory scales after passing 100 meters. The weight loss was measured five times, and the total distance travelled was 500 m.

The intensity of volume wear is the most complex indicator of the wear of material and was calculated by the relation:

$$W_{V/s} = \frac{W_m}{\rho s} \text{ (mm}^3 \text{ m}^{-1}\text{)}, \quad (8)$$

where W_m is the weight loss of the specimen (g), ρ is the specific weight of steel ($\rho = 7.850 \times 10^{-3} \text{ g mm}^{-3}$), and s is the travelled track of the pin during the test ($s = 100 \text{ m}$).

Table 8. Results of the adhesive wear test

| Properties | Reference material 50MnSi4 | Carbofil A 350 | Magmaweld FCH 360 |
|--|----------------------------|----------------------|----------------------|
| Coefficient of friction μ (-) | 2×10^{-1} | 3.3×10^{-1} | 1.3×10^{-1} |
| Weight loss of the specimen W_m (g) | 18.3×10^{-1} | 34×10^{-4} | 3×10^{-4} |
| Intensity of the volume wear $W_{V/s}$ ($\text{mm}^3 \text{m}^{-1}$) | 4.7×10^{-1} | 8.5×10^{-4} | 1.5×10^{-4} |

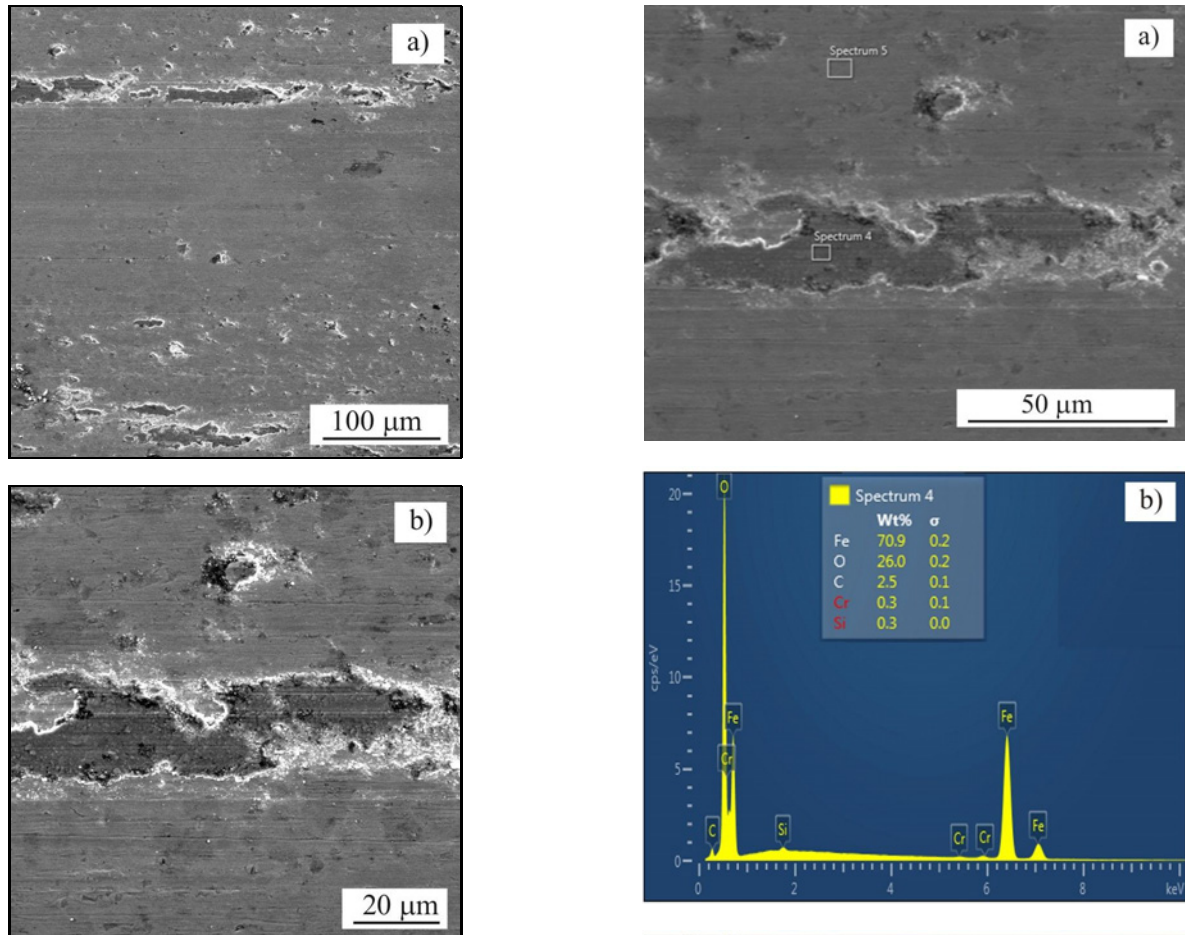

Fig. 16. SEM of the worn surface made of Carbofil A 350 filler metal after adhesive wear testing: (a) general view and (b) detail of the transferred material.

Table 8 compares the average property values of the reference material and the hardfaced samples used from the adhesive wear tests. The results show the difference in the coefficient of friction of the reference specimen and the specimens with hardfacings. We recorded the lowest average friction coefficient value of 0.131 using the Magmaweld FCH 360 filler metal. This value is 2.5 times lower than the coefficient of friction of specimens with the Carbofil A 350 deposit (0.331) and 1.5 times lower than that of the reference specimen.

The data shows that the best results of resistance to adhesive wear were on specimens with hardfacing

Fig. 17. EDX analysis of selected areas of the Carbofil A 350 hardfacing after the adhesive wear test: (a) analyzed areas, (b) semi-quantitative analysis of the “Spectrum 4” area, and (c) semi-quantitative analysis of the “Spectrum 5” area.

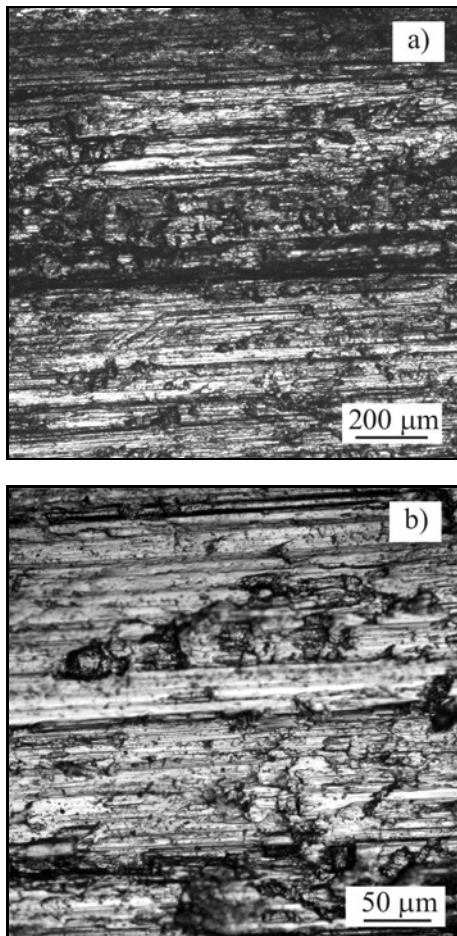

Fig. 18. Worn surface of the disc made of 50MnSi4 steel (reference material) after the adhesive wear test: (a) general view and (b) detail of the transferred material.

of Magmaweld FCH 360 filler metal. In these cases, we found the minimum weight loss W_m (g) and the lowest intensity of volume wear $W_{V/s}$ ($\text{mm}^3 \text{m}^{-1}$). The difference in the evaluated parameters on the specimens with wear-resistant deposits was 10 and 5.5 times, respectively.

When comparing the resistance to adhesive wear of both types of hardfacing alloys with the reference material, it can be stated that the specimens provided with the overlay showed an order of magnitude ($\times 10^3$) higher resistance than the reference material (50MnSi4 steel). It has been shown that selected types of hardfacing alloys significantly reduce the adhesive wear of the 50MnSi4 steel.

The worn surfaces of the deposits, as well as the discs after the wear test, are shown in Figs. 16 and 17. The surfaces of the hardfacing made of the Carbofil A 350 filler metal subjected to the adhesive wear showed a smooth surface with the local occurrence of wear fragments (Fig. 16). Their location corresponded to the sliding direction. The material transferred from

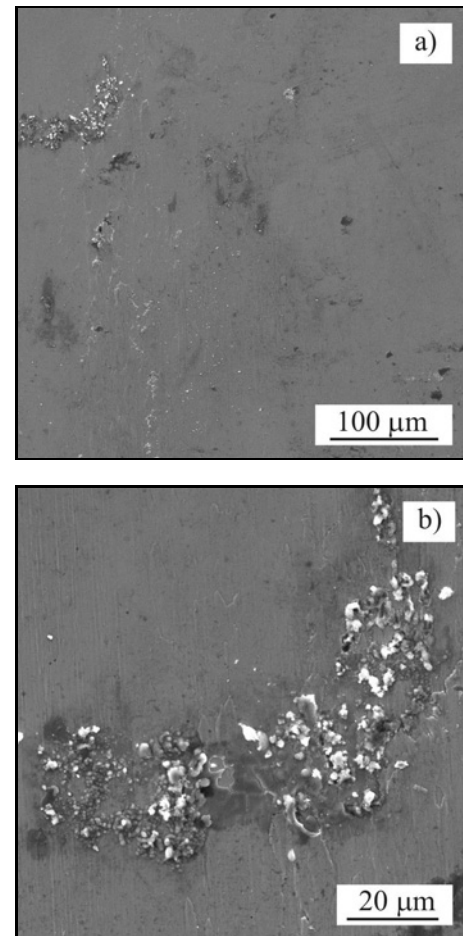

Fig. 19. SEM of the worn surface made of Magmaweld FCH 360 filler metal after the adhesive wear test: (a) general view and (b) detail of the transferred material.

the disc to the deposit was subjected not only to strain hardening but also to oxidation when heated by friction, which was confirmed by EDX analysis of the transferred material of the disc (Fig. 17).

The surface of the disc showed significantly different wear after the adhesive wear test (Fig. 18). The difference was due to a significant difference in the hardness of the disc material (226HV_{10}) and the Carbofil A 350 hardfacing ($586 \text{HV}_{0.2}$).

Upon contact of the hardfacing with the disc material, plastic deformation of the softer disc material occurred in the contact area. The occurrence of microcracks in the deformed subsurface layer and brittle fracture in the region of the maximum shear stress caused delamination of the surface layers of the 50MnSi4 steel, which is documented in Fig. 18b. In the delamination wear mode, the particles were rapidly separated from the subsurface layers by low cycle fatigue wear [4].

After testing, the worn surface made of Magmaweld FCH 360 filler metal showed an equally

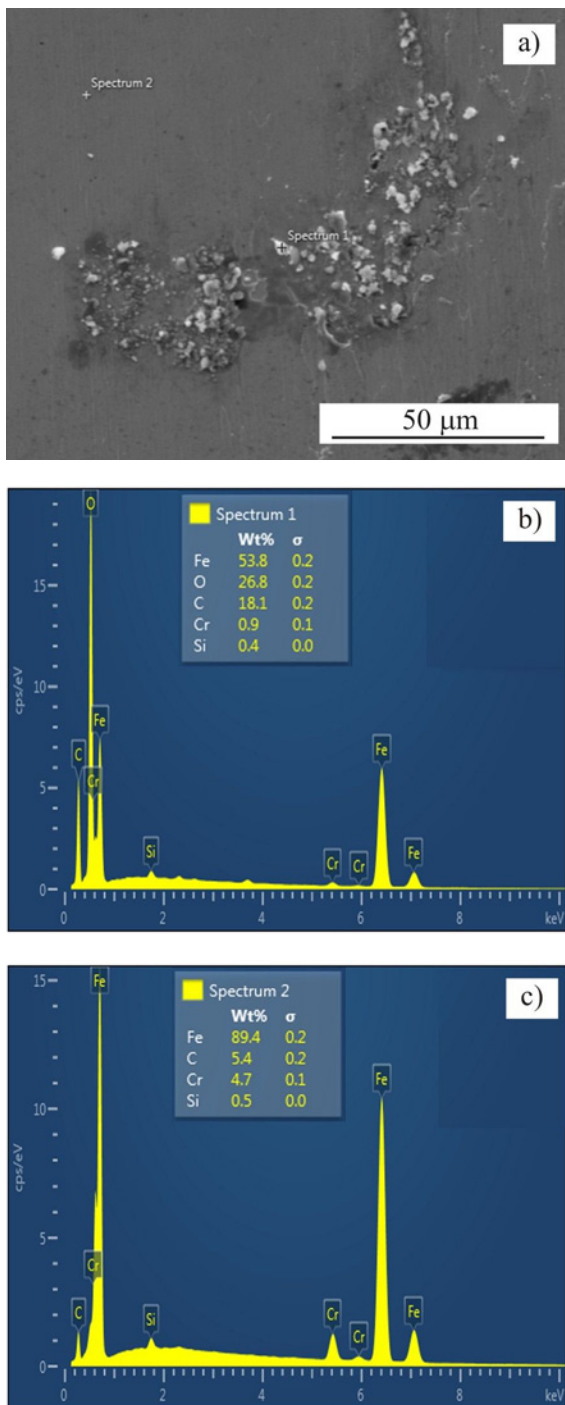

Fig. 20. EDX analysis of selected areas of the Magmaweld FCH 360 hardfacing after the adhesive wear test: (a) analyzed areas, (b) semi-quantitative analysis of the “Spectrum 1” area, and (c) semi-quantitative analysis of the “Spectrum 2” area.

smooth surface with a rare occurrence of small wear fragments (Fig. 19). Here, too, the oxidation of the transferred material from the disc to the deposit was found, which was confirmed by EDX analysis of selected areas on the hardfacing surface after the wear test (Fig. 20).

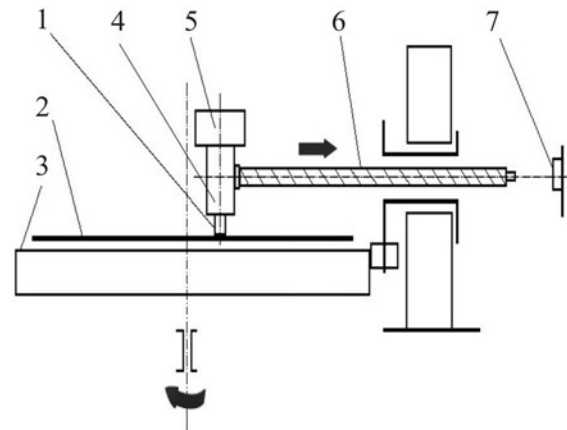

Fig. 21. Equipment for testing the resistance of materials to abrasive wear (1 – test specimen, 2 – sandpaper, 3 – disc, 4 – specimen holder, 5 – weight, 6 – mechanism ensuring the radial movement of the specimen, 7 – electric motor).

The worn surface of the disc made of 50MnSi4 steel (reference material) was the same when testing the hardfacings made of Magmaweld FCH 360 filler metal as when testing deposits made of Carbofil A 350 metal (Fig. 18).

3.3. Abrasive wear characteristics of hardfacing alloys

As in the adhesive wear test, the 8 mm diameter pins (Fig. 12) were used in the abrasive wear test (Fig. 21). The test specimens (no. 1) were placed in a holder (no. 4), which allowed the pin to come into contact with the corundum sandpaper (no. 2) with a grain size of 120 μm during the test. The test was run dry. The maximum sliding speed was 0.05 m s^{-1} , with a radial movement of the specimen of 1.5 mm per 1 revolution of the disc (no. 3). The total distance travelled was 125 m, the applied pressure derived by the weight was 0.023 MPa (p_1), and 0.470 MPa (p_2). The higher-pressure value was chosen so that after the test, the thickness of the deposit on the pin remained at least 40 % of the original layer, and the result was not affected by the overlay/substrate intermixing structure.

The resistance to abrasive wear was evaluated based on the weight loss of the test specimens W_m (g). The data obtained from the abrasive wear test are given in Table 9.

From the data in Table 9, it is clear that both hardfacing alloys used had a higher resistance to abrasive wear than the reference material, which was recorded using lower and higher pressure on the specimen during the test. Specifically, at a test pressure of 0.47 MPa, the resistance of the Carbofil A 350 deposit was 1.6 times higher, and at Magmaweld FCH 360, the resistance was up to 2.7 times higher compared to

Table 9. Results of the abrasion wear test

| Pressure applied on the specimen (MPa) | Weight loss of reference material 50MnSi4 (g) | Weight loss of Carbofil A 350 (g) | Weight loss of Magmaweld FCH 360 (g) |
|--|---|-----------------------------------|--------------------------------------|
| $p_1 = 0.023$ | 4.2×10^{-2} | 2.4×10^{-2} | 1.7×10^{-2} |
| $p_2 = 0.47$ | 88.3×10^{-2} | 56.1×10^{-2} | 32.6×10^{-2} |

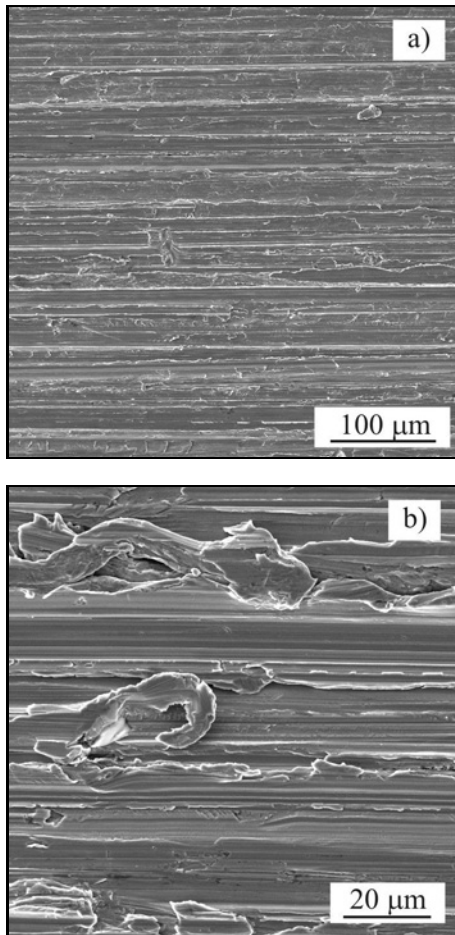

Fig. 22. SEM of the specimen worn surface with hardfacing of Carbofil A 350 alloy after abrasive wear test at pressure $p_2 = 0.47$ MPa: (a) general view and (b) detail of the wear scars.

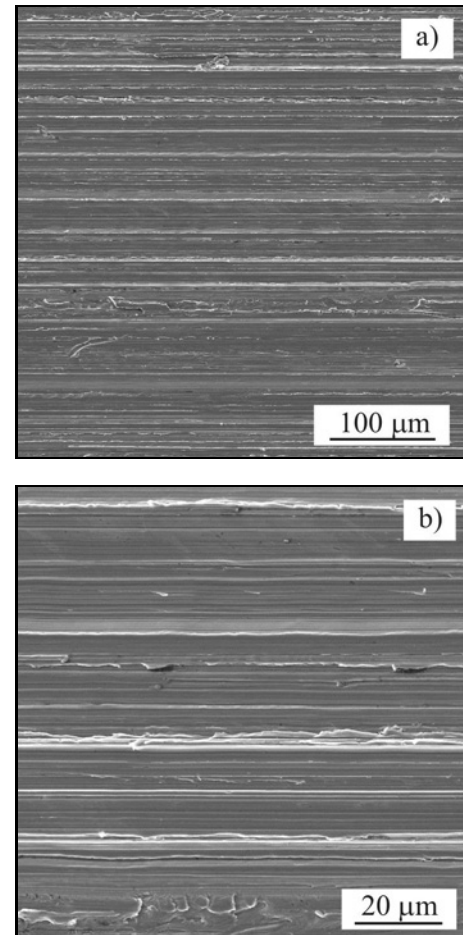

Fig. 23. SEM of the specimen worn surface with hardfacing of Magmaweld FCH 360 after abrasive wear test at pressure $p_2 = 0.47$ MPa: (a) general view and (b) detail of the wear scars.

the resistance of the substrate material 50MnSi4.

When comparing hardfacings, it can be stated that the Magmaweld FCH 360 filler metal had 1.7 times higher resistance to abrasive wear, evaluated by weight loss of the test specimen, than the deposit from Carbofil A 350 filler metal. In this case, the higher hardness of the Magmaweld FCH 360 hardfacing (up to 719 HV_{0.2}, Fig. 10) compared to the Carbofil A 350 overlay (max. 586 HV_{0.2}, Fig. 6) played a decisive role in assessing wear resistance.

The surfaces of the test specimens after the abrasive wear test are shown in Figs. 22 to 24. Figure 22 shows grooves after pushing the hard abrasive parti-

cles into the surface of the Carbofil A 350 hardfacing and the subsequent application of tangential forces between the abrasive and the specimen surface. In detail (Fig. 22b), primary debris and microchips of material displaced to the sides of the grooves during micro-cutting can be seen.

The higher hardness of the Magmaweld FCH 360 filler metal resulted in a shallower penetration of the abrasive grains during the wear test (Fig. 23) and a lower overall wear level compared to Carbofil A 350 filler metal (Table 9). During the test, micro-cutting occurred with a small amount of material displacement.

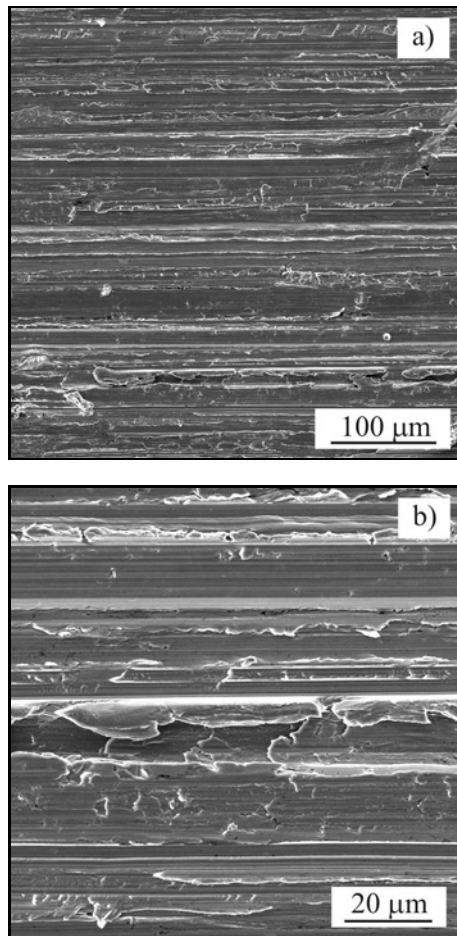

Fig. 24. SEM of the reference specimen worn surface made of 50MnSi4 steel after abrasive wear test at pressure $p_2 = 0.47$ MPa: (a) general view and (b) detail of the wear scars.

The highest abrasive wear intensity was recorded on a 50MnSi4 steel reference material due to the deep penetration by the abrasive particles. Wear scars on the worn surfaces document the intensive removal of material by micro-cutting with hard abrasive particles (Fig. 24).

4. Conclusions

The work aimed to compare the suitability of selected types of hardfacing materials, Carbofil A 350 and Magmaweld FCH 360, to increase the resistance of steel 50MnSi4 to adhesive and abrasive wear. Based on the achieved results, the following conclusions can be drawn:

1. The deposit made with the Carbofil A 350 filler metal did not show any defects and had a typical martensitic structure with a maximum hardness of 586 HV_{0.2}, which was higher than the value declared by the manufacturer (400 HV). The difference be-

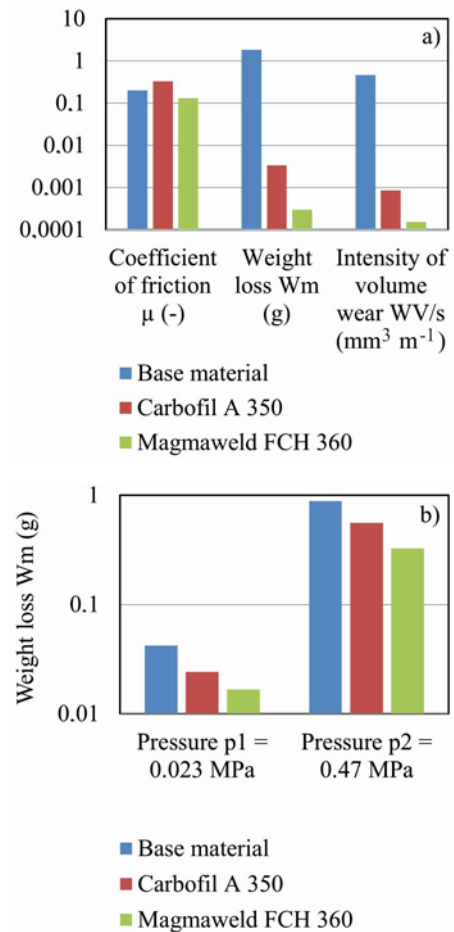

Fig. 25. Evaluation of the wear resistance of the hardfacings and the reference specimen to (a) adhesive and (b) abrasive wear.

tween the minimum and maximum hardness values measured in the overlay was only 35 HV_{0.2}.

2. Near the overlay/substrate interface, cracks with a length of 0.2 to 0.8 mm were identified in the hardfacing made of Magmaweld FCH 360 filler metal. The structure of the hardfacing was martensitic, too. However, the difference in the measured hardness values was significantly more significant (211 HV_{0.2}) – from the maximum value of 719 HV_{0.2} to the minimum of 508 HV_{0.2}. The average value of the hardness of the deposit approximately corresponded to the data of the filler metal manufacturer (675 HV).

3. From the results of the “Pin on Disc” test (Fig. 25a), it is possible to state differences in the behavior of hardfacings exposed to adhesive wear to a disc made of 50MnSi4 steel. The wear resistance was evaluated by the coefficient of friction, weight loss and the intensity of volume wear. The lowest average value of the coefficient of friction (0.131) was measured on the specimen with Magmaweld FCH 360 deposit. The coefficient of friction

obtained in the tests of specimens with Carbofil A 350 filler metal was 2.5 times higher (0.331). Also, when comparing the results obtained in the calculation of weight loss and intensity of volume wear, it can be stated that the filler metal Magmaweld FCH 360 is more suitable in terms of resistance to adhesive wear ($W_{m\text{CarbofilA350}} = 34 \times 10^{-4}$ g, $W_{m\text{MagamaweldFCH360}} = 3 \times 10^{-4}$ g, $W_{V/s\text{CarbofilA350}} = 8.5 \times 10^{-4}$ mm³ m⁻¹, $W_{V/s\text{MagamaweldFCH360}} = 1.5 \times 10^{-4}$ mm³ m⁻¹). However, we recorded the largest differences in the parameters evaluating the resistance to adhesive wear when comparing the results of specimens with hardfacings and a reference specimen made of the base material 50MnSi4 steel. The resistance of both selected filler metals for the production of the coatings (Carbofil A350, Magmaweld FCH360) was an order of magnitude higher (Fig. 25a). It has been shown that both types of filler metals significantly reduce the adhesive wear of the 50MnSi4 steel.

4. From the abrasion wear resistance tests, it is clear (Fig. 25b) that the higher hardness of the deposit obtained using Magmaweld FCH 360 filler metal (up to 719 HV_{0.2}) provides higher resistance than the softer hardfacing by applying Carbofil A 350 alloy (max. 586 HV_{0.2}). The difference in the weight loss of the specimens after the test on sandpaper with a corundum grain of 120 μm at a pressure of 0.47 MPa was 1.7 times ($\Delta m_{\text{MagamaweldFCH360}} = 0.326$ g, $\Delta m_{\text{CarbofilA350}} = 0.561$ g). Also, in this case, the largest extent of wear was measured on the reference specimen ($\Delta m_{50\text{MnSi4}} = 0.883$ g). The main reason for the high wear intensity is the low hardness of the base material (226 HV₁₀) compared to the hardness of the hardfacings.

Finally, it can be stated that both selected types of welding filler metals provide increased resistance of the base material 50MnSi4 steel to both adhesive and abrasive wear. A comparison of the overlay properties shows that the high hardness of the hardfacing obtained from the Magmaweld FCH 360 filler metal provides excellent adhesive resistance of 50MnSi4 steel and higher abrasion resistance than the lower hardness deposit obtained from the Carbofil A 350 filler metal. The disadvantage of applying Magmaweld FCH 360 filler metal is that it is prone to cracking in the hardfacing near the overlay/substrate interface despite the preheating used.

Acknowledgement

This work was supported by the University Science Park STU Bratislava "ITMS" code 26240220084.

References

- [1] B. Bhushan, Introduction to Tribology, 2nd Edition, John Wiley & Sons, 2013, ISBN 978-1-119-94453-9.
- [2] A. Matthews, S. Franklin, K. Holmberg, Tribological coatings: contact mechanisms and selection, J. Phys. D: Appl. Phys. 40 (2007) 5463. <http://doi.org/10.1088/0022-3727/40/18/S07>
- [3] G. W. Stachowiak, Wear – Materials, Mechanisms and Practice. John Wiley & Sons, 2005, ISBN-13: 978-0-470-01628-2.
- [4] K. Holmberg, A. Matthews, Coatings Tribology – Properties, Mechanisms, Techniques and Applications in Surface Engineering, 2nd Edition, Elsevier, 2009, ISBN: 978-0-444-52750-9.
- [5] Jun-Sheng Menga, Guo Jin, Xiao-Ping Shib, Structure and tribological properties of argon arc cladding Ni-based nanocrystalline coatings, Applied Surface Science 431 (2018) 135–142. <http://doi.org/10.1016/j.apsusc.2017.05.238>
- [6] V. Balasubramanian, R. Varahamoorthy, C. S. Ramachandran, C. Muralidharan, Selection of welding process for hardfacing on carbon steels based on quantitative and qualitative factors, Int. J. Adv. Manuf. Technol. 40 (2009) 887–897. <https://doi.org/10.1007/s00170-008-1406-8>
- [7] M. K. Saha, R. Hazra, A. Mondal, S. Das, Effect of heat input on geometry of austenitic stainless steel weld bead on low carbon steel, J. Inst. Eng. India C 100 (2019) 607–615. <https://doi.org/10.1007/s40032-018-0461-7>
- [8] B. Xue, W. Lei, X. Liu, S. Chen, Effect of medium entropy alloy powder-core wire on friction wear and corrosion resistance of arc cladding additive layer, Mater. Res. Express 7 (2020) 076521. <https://doi.org/10.1088/2053-1591/aba84f>
- [9] A. O'Brien, Welding Handbook, 9th Edition, Vol. 2, Welding Processes, Part 1. American Welding Society, 2004, ISBN: 0-87171-729-8.
- [10] M. Gucwa, J. Winczek, R. Bęczkowski, M. Dośpał, Structure and properties of coatings made with self shielded cored wire, Archives of Foundry Engineering 16 (2016) 39–42. <https://doi.org/10.1515/afe-2016-0046>
- [11] Y. F. Zhoua, Y. L. Yanga, Y. W. Jianga, J. Yanga, X. J. Renb, Q. X. Yanga, Fe-24wt.%Cr-4.1wt.%C hardfacing alloy: Microstructure and carbide refinement mechanisms with ceria additive, Materials Characterization 72 (2012) 77–86. <https://doi.org/10.1016/j.matchar.2012.07.004>
- [12] B. Venkatesha, K. Sriker, V. S. V. Prabhakar, Wear characteristics of hardfacing alloys: State-of-the-art, Procedia Materials Science 10 (2015) 527–532. <https://doi.org/10.1016/j.mspro.2015.06.002>
- [13] M. Ban, N. Hasegawa, Y. Ueno, H. Shinozaki, T. Aoki, H. Fukumoto, Wear resistance property of hardfacing weld overlays containing metal carbides, Tribology Online 7 (2012) 207–212. <https://doi.org/10.2474/trol.7.207>
- [14] Y. Ali, K. Guenther, A. Burt, J. P. Bergmann, Laser-assisted GMAW hardfacing, Welding Journal 94 (2015) 367–373.
- [15] P. Chattopadhyay, V. van der Mee, Z. Zhang, Hybrid electrosag cladding (H-ESC): An innovation in high

- speed electrosag strip cladding, *Welding in the World* 63 (2019) 663–672.
<https://doi.org/10.1007/s40194-018-00692-y>
- [16] J. Jianga, Y. Xiea, W. Qiana, R. Hallb, Important factors affecting the gouging abrasion resistance of materials, *Minerals Engineering* 128 (2018) 238–246.
<https://doi.org/10.1016/j.mineng.2018.09.001>
- [17] M. Gucwa, R. Beczkowski, T. Wylecial, The Effect of the Hardfacing Sequence on the Structure and Erosion Resistance of High Chromium Alloy. *METAL 2017*, Brno, Czech Republic, pp. 1281–1286. ISBN 978-808729479-6
- [18] L. Zong, Y. Zhao, S. Long, N. Guo, Effect of Nb content on the microstructure and wear resistance of Fe-12Cr-*x*Nb-4C coatings prepared by plasma-transferred arc welding, *MDPI Coatings* 10 (2020) 585.
<https://doi.org/10.3390/coatings10060585>
- [19] A. Vencl, B. Katavić, D. Marković, M. Ristić, B. Gligorijević, The tribological performance of hardfaced/thermal sprayed coatings for increasing the wear resistance of ventilation mill working parts, *Tribology in Industry* 37 (2015) 320–329.
- [20] H. Durmuşa, N. Çömeza, C. Güla, M. Yurddaşkalb, M. Yurddaşkalc, Wear performance of Fe-Cr-C-B hardfacing coatings: Dry sand/rubber wheel test and ball-on-disc test, *International Journal of Refractory Metals & Hard Materials* 77 (2018) 37–43.
<https://doi.org/10.1016/j.ijrmhm.2018.07.006>
- [21] E. O. Correa, N. G. Alcântara, L. C. Valeriano, N. D. Barbedo, R. R. Chaves, The effect of microstructure on abrasive wear of a Fe-Cr-C-Nb hardfacing alloy deposited by the open arc welding process, *Surface & Coatings Technology* 276 (2015) 479–484.
<http://doi.org/10.1016/j.surfcoat.2015.06.026>
- [22] H. Li, M. Zhuang, Ch. Li, S. Wu, S. Rong, Effect of C Element Change on Microstructure and Properties of Fe-Cr-C Surfacing Alloy, *IOP Conf. Series: Earth and Environmental Science* 186 (2018) 012018.
<http://doi.org/10.1088/1755-1315/186/2/012018>
- [23] N. Yuksel, S. Sahin, Wear behavior-hardness-microstructure relation of Fe-Cr-C and Fe-Cr-C-B based hardfacing alloys, *Materials and Design* 58 (2014) 491–498.
<http://doi.org/10.1016/j.matdes.2014.02.032>
- [24] A. I. Guseva, A. A. Usoftseva, N. A. Kozyreva, N. V. Kibkoa, L. P. Bashchenkoa, Flux-cored wire for the surfacing of parts subject to wear, *Steel in Translation* 48 (2018) 724–731.
<http://doi.org/10.3103/S0967091218110037>
- [25] M. F. Buchely, J. C. Gutierrez, L. M. León, A. Toro, The effect of microstructure on abrasive wear of hardfacing alloys, *Wear* 259 (2005) 52–61.
<http://doi.org/10.1016/j.wear.2005.03.002>
- [26] J. Truhan, R. Menonb, F. LeClaire, J. Wallin, J. Quc, P. Blau, The friction and wear of various hard-face claddings for deep-hole drilling, *Wear* 263 (2007) 234–239.
<http://doi.org/10.1016/j.wear.2007.01.046>
- [27] M. Kirchgäßner, E. Badisch, F. Franek, Behaviour of iron-based hardfacing alloys under abrasion and impact, *Wear* 265 (2008) 772–779.
<http://doi.org/10.1016/j.wear.2008.01.004>
- [28] S. Kou: *Welding Metallurgy*, 2nd Edition, John Wiley & Sons, 2002, ISBN 0-471-43491-4.
- [29] J. C. Lippold, *Welding Metallurgy and Weldability*, John Wiley & Sons, 2015, ISBN 978-1-118-23070-1.
- [30] D. L. Olson, T. A. Siewert, S. Liu, G. R. Edwards, *ASM Handbook, Vol. 6, Welding, Brazing, and Soldering*, ASM International, 1993, ISBN 0-87170-377-7.
- [31] CARBOFIL A 350, Oerlikon, 25.05.2022, online: <http://www.oerlikonline.hu/files/241.pdf>
- [32] FCH 360, Flux Cored Wires, Magmaweld, 25.05.2022, online: <https://www.magmaweld.com/welding-consumables/hardfacing-products/flux-cored-wires/fch-360/uo/fch-360>
- [33] D. Séférian, *Métallurgie de la Soudure*, Dunod, Paris, France, 1965.